

# THERMOSTAT



INSTALLATION AND USER MANUAL **EN**



 **OLIMPIA  
SPLENDID**  
HOME OF COMFORT



# INSTALLATION

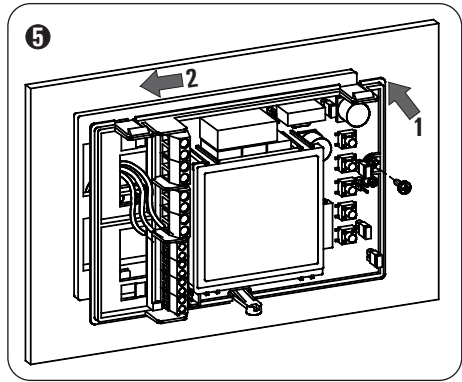
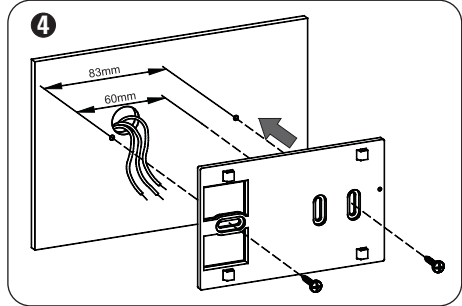
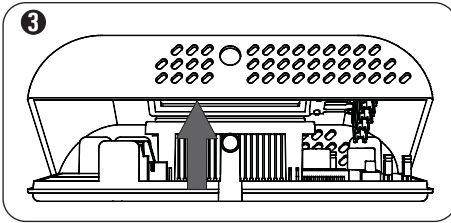
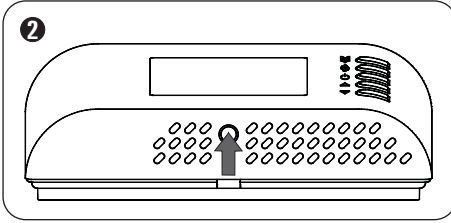
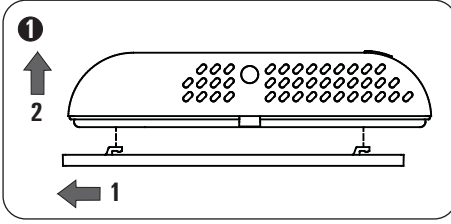

## 6 JUMPER CONFIGURATION

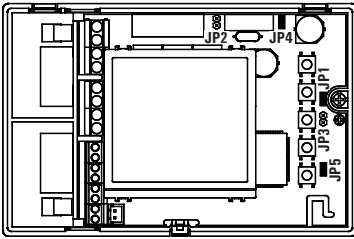

- JP1 230 V~ power supply (factory setting)
- JP2 24 V~ power supply
- JP1 50Hz frequency (factory setting)
- JP2 60Hz frequency
- JP3 Parameter setting enabled
- JP4 Parameter setting disabled

**7** Install the electrical connections in accordance with the appropriate wiring diagram (page 3) and the possible variants (page 4); read the "electrical connections" paragraph carefully.

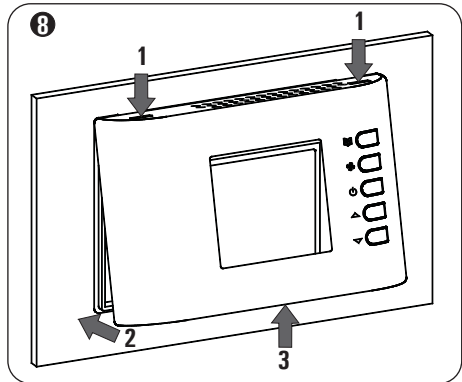

# WIRING DIAGRAM

## LEGEND

<b>JP2:</b>	Select 230/24 V~
<b>V HEAT:</b>	0..10 V heating signal output
<b>V COOL:</b>	0..10 V cooling signal output
<b>V FAN:</b>	0..10V fan signal output
<b>HEAT:</b>	Heating valve output
<b>COOL:</b>	Cooling valve output
<b>E/I:</b>	Remote input for activating the "Centralised Heating/Cooling" function
<b>RDC:</b>	Remote input for activating the "Economy" function
<b>M:</b>	Fan motor
<b>ECM:</b>	Electronically commutated motor
<b>Sc:</b>	0..10V Servo drive
<b>S.M.:</b>	Supply sensor
<b>S.A.:</b>	Room sensor
<b>CF:</b>	Remote input for activating the "Window contact" (*) function
<b>RS:</b>	Remote room temperature sensor connection. See "Electric connections"
<b>-- :</b>	Reinforced insulation

(\*) The function associated with the input may be modified in parameters C17, C18 and C19.

## **WARNING!**

*The function associated with terminal 8 may be modified in parameter C23.*



Wiring diagram for driving 2 on-off 230 V~ actuators in 4 pipe systems with proportional fan drive.

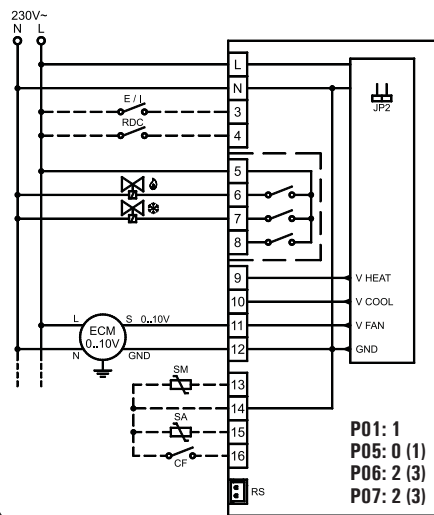

Wiring diagram for driving 2 on-off 24 V~ actuators in 4 pipe systems with proportional fan drive.

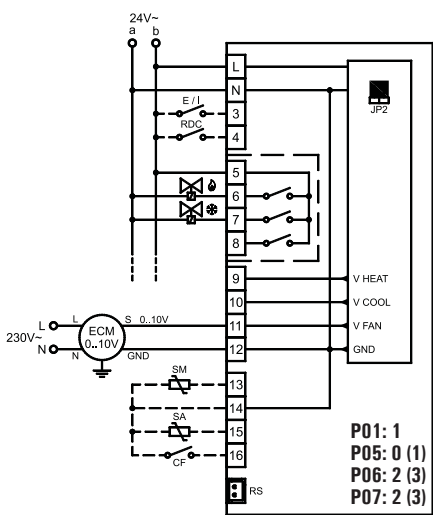

Wiring diagram for driving two 0..10V 24 V~ actuators in 4 pipe systems and a 230 V three speed motor.

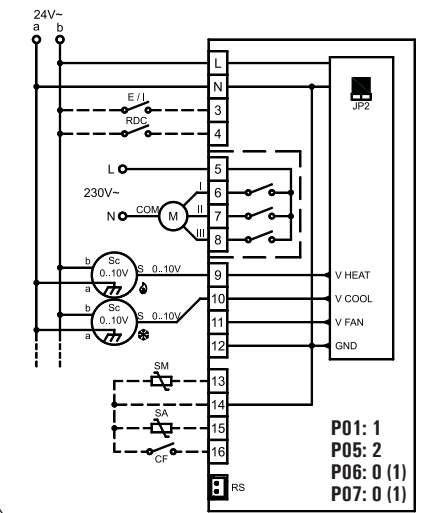

Wiring diagram for driving a 0..10V 24 V~ actuator for an integrated heating element system and a proportional fan drive.

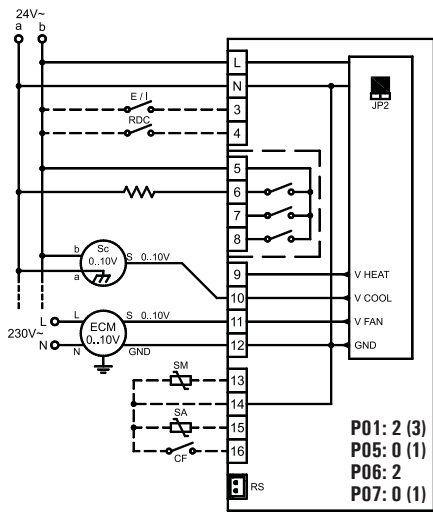

2-pipe system with ON-OFF valve.

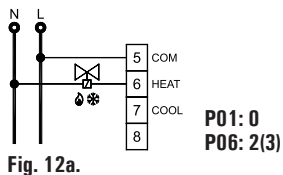

2-pipe system with 0..10V servo drive.

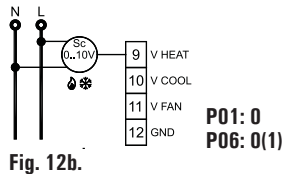

4-Pipe system with two ON-OFF valves.

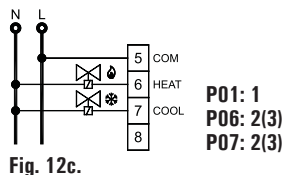

4-pipe system with two 0..10V servo drives.

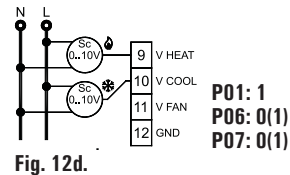

Integrated electric heating element system with ON-OFF valve.

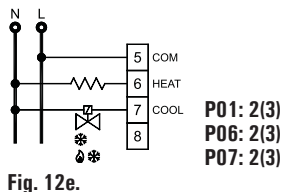

Integrated electric heating element system with 0..10V servo drive

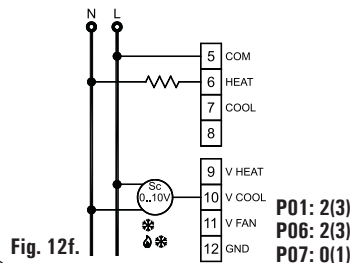

Connecting a proportional fan to an EC motor with 0..10V input.

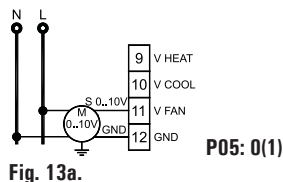

Connecting a fan to a three speed motor.

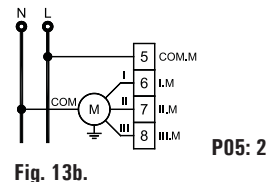

## OUTPUT DRIVE SEQUENCES

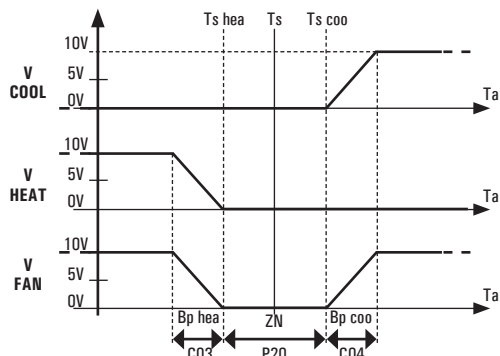

The diagram illustrates the valve drive sequence in a 4-pipe system with neutral zone. In the diagram it is assumed that the outputs are configured for proportional direct action (0..10V), while any effects of the supplementary time are disregarded. Similarly, in the case of a 2-pipe system, the valve output (heating valve output) would be driven at the same way. In this case **Ts** (set-point temperature) would coincide with **Ts ris** in winter, and **Ts raf** in summer.

### LEGEND

<b>V COOL:</b>	Cooling valve proportional output
<b>V HEAT:</b>	Heating valve proportional output
<b>V FAN:</b>	Fan proportional output
<b>HEAT:</b>	ON-OFF Heating valve output
<b>COOL:</b>	ON-OFF Cooling valve output
<b>Ta:</b>	Room temperature
<b>Ts:</b>	Set-point temperature
<b>Ts hea:</b>	Heating set-point temperature
<b>Ts coo:</b>	Cooling set-point temperature
<b>ist:</b>	Ambient temperature hysteresis
<b>Bp hea:</b>	Heating proportional band
<b>ZN:</b>	Neutral zone amplitude
<b>Bp coo:</b>	Cooling proportional band

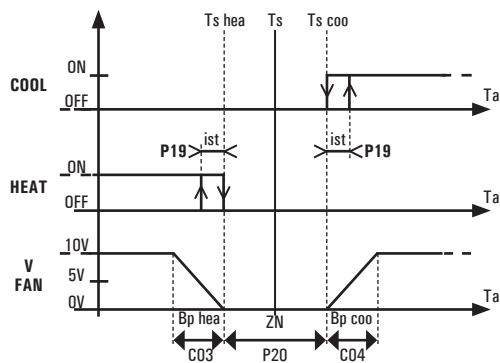

The diagram illustrates the valve drive sequence in a 4-pipe system with neutral zone. Similarly, the heating valve output (HEAT) in a 2-pipe system would be driven in the same way. In this case, **Ts** (set-point temperature) would coincide with **Ts ris** in winter and **Ts raf** in summer.

This diagram disregards the effects of the supplementary time, if any, and assumes that the fan proportional output (V FAN) is configured for direct action (P05=0) and a 0..10V signal (C15=0; C16=100). The fan proportional output is always turned off (0V) when the COOL or HEAT valve output, is off (not shown on the diagram).

### LEGEND

<b>V COOL:</b>	Cooling valve proportional output
<b>V HEAT:</b>	Heating valve proportional output
<b>V FAN:</b>	Fan proportional output
<b>HEAT:</b>	ON-OFF Heating valve output
<b>COOL:</b>	ON-OFF Cooling valve output
<b>Ta:</b>	Room temperature
<b>Ts:</b>	Set-point temperature
<b>Ts hea:</b>	Heating set-point temperature
<b>Ts coo:</b>	Cooling set-point temperature
<b>ist:</b>	Ambient temperature hysteresis
<b>Bp hea:</b>	Heating proportional band
<b>ZN:</b>	Neutral zone amplitude
<b>Bp coo:</b>	Cooling proportional band

## GENERAL INFORMATION

This integrated electronic regulation device is a digital thermostat for controlling the temperature in rooms that are heated or cooled by fan coil units. It provides continuous, proportional control over the valves and fan via 0..10V outputs, opening the former and regulating the speed of the latter so as to ensure the room temperature is as pleasant as possible.

The device is also fitted with three ON/OFF relay outputs that can be used to control a fan with three speed settings or two ON/OFF actuators. The room temperature can be monitored by the internal or remote probe (optional).

## DESCRIPTION OF CONTROLS

The controller is equipped with five control buttons.

### (On/Off) button

Use this button to switch the controller on and off: when the controller is switched off the temperature is not displayed, although some symbols may still be active, depending on the status of the outputs. If the controller is configured for the "Economy" function (P18), press the  button to activate/deactivate this status according to the following diagram:



### (Speed) button

Use this button to modify the fan speed setting as desired.

Each time the user presses the  button, the fan speed is modified in the following sequence:

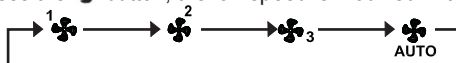

where 1, 2 and 3 correspond to the three fixed fan speeds, while AUTO corresponds to the automatic fan speed. More specifically, 1 corresponds to the lowest speed, 2 the medium speed and 3 the highest.

This means that, when the operator selects one of the above settings, when required, the fan will always be activated at the corresponding speed.

If, on the other hand, the operator selects automatic speed, the greater the need to heat or cool the environment, the higher the speed the controller activates the fan at.

If the controller is configured to control the fan via the 0..10V proportional output, it is to configure the three fixed speeds to the desired values via the parameters C11, C12 and C13.

Parameter C10 may be used to customize the speeds, which can be recalled up by pressing the  button, and to enable the OFF function, which prevents the fan from being activated.

### (Menu) button

Use this button to change the display readout mode: press once to display the set-point temperature. In case the controller is configured to show the supply water temperature, press this button again to display this value.

When changing the readout, the controller notifies the operator which temperature value is currently displayed according to the following table:

 Set-point temperature -  Supply water temperature

Press the button to cyclically to display the various temperatures. When inactive for a few seconds the display reverts to the room temperature.

## Button $\triangle$ and $\nabla$























Use these buttons to select the desired room temperature (set-point) and the configuration parameters. If the operator presses  $\triangle$  or  $\nabla$  during normal operation, the set-point temperature is displayed, along with the new set value. As above, after a few seconds of inactivity the display readout reverts to the room temperature.

## DISPLAY INDICATION

The controller is equipped with an LCD display, which indicates the temperature and settings.

### Displayed symbols:

The symbols that may appear on the display are described in the following table:



	Automatic heating/cooling selection. The controller switches automatically between heating/cooling modes.		Heating element active (electric heater systems only).
	Fixed low fan speed setting.		Heating active.
	Fixed medium fan speed setting.		Cooling active.
	Fixed high fan speed setting.		Regulation suspended; the contact has detected an open window
	Automatic fan speed setting.		The supply water temperature is too low (heating) or too high (cooling).
	Controller configuration in progress.		Installer configuration error or alarm.
	Clogged filter (the filter must be cleaned).		Condensate alarm: regulation is suspended.
	Function not available.		Motor alarm.
	Display water temperature value.		Valve error.
	Set-point temperature value.		Occupied room: regulation reactivated or exit "Economy" mode deactivated.
	Temperature regulation in "Economy" mode.		Unoccupied room: regulation suspended or "Economy" mode activated.
	Antifreeze mode active: the controller regulates the antifreeze temperature.		

The display also includes a series of symbols that indicate the status of the outputs, the fan, the valves or any other connected loads.



The “fan speed” symbols indicate the fan status: when they are all extinguished, it indicates that the fan is off, whereas when they are illuminated it indicates that the fan is on, according to the following indications:





If the controller is configured to control the fan via the 0..10V proportional output, the higher the fan speed, the more fan dashes will be displayed in the fan symbol.

The symbols  and  indicate the status of the valve outputs, which varies depending on the type of system.



#### Two pipe system:

	heating mode, valve open
	cooling mode, valve open



#### Four pipe system:

	heating valve open
	cooling valve open

#### System with heating element:

	heating mode, heating element on
	cooling mode, cooling valve open

#### System with integrated heating element:

	heating mode, valve open
	cooling mode, valve open
	heating mode, heating element on

The symbols associated with a proportional valve output are displayed even if the proportional valve is set to a minimum opening position.

The symbols may also flash, indicating that the corresponding output should be on, but is temporarily disabled by another function.

**For example, the outputs are disabled in the following situations:**

- The minimum temperature thermostat function is inhibiting the fan;
- The window contact has suspended temperature regulation.

## INSTALLATION

To install the device, proceed as follows, with reference to the figures on page 1:

1. Release the plate attached to the controller base by pushing it to the left and releasing the teeth shown in the figure.
2. Push the plastic tab in the lower slot using a screwdriver, raising the cover slightly.
3. Rotate the cover, while pressing it gently, until it is fully extracted.
4. Secure the plate to the wall, using the two screw holes with pitch distances of 60 mm or 85 mm (use the wall plugs and/or screws supplied), and feed the wires through the rectangular openings.
5. - Attach the controller base to the wall plate (passing the wires through the rectangular openings), first making sure the holes on the base are aligned with the corresponding teeth on the wall plate, and then pressing the base to the left so the plastic teeth on the plate click into place.
  - Secure the controller base to the wall using the screw provided.
6. If necessary, configure the jumpers JP1, JP2, JP3, JP4 and JP5. Read carefully “JUMPER SELECTION” (page 5) and “ELECTRICAL CONNECTIONS” paragraphs.

7. Install the electrical connections in accordance with the appropriate wiring diagram (page 3) and the possible variants (page 4). Read the “ELECTRICAL CONNECTIONS” paragraph carefully.
8. To close the controller again, proceed as follows:
  - Position the two teeth on the upper part of the cover so they enter the corresponding notches.
  - Rotate the cover and push the plastic tab inward on the lower part of the base (identified by the arrow). Press it so that the plastic locking tab clicks into place in the corresponding hole.

## **WARNING**

- ***The supply water sensor must be installed so it can monitor the water temperature correctly, even if the valve interrupts the flow.***
- ***The same remote temperature sensor may not be connected to the terminals of more than one controller.***
- ***The remote sensors, bimetallic contact and window contact connected to the controller must be isolated from earth and the mains supply voltage.***
- ***Failure to observe the above two conditions may result in irreversible damage to the product.***
- ***The remote sensors, bimetallic contact and window contact must be double insulation (or fitted with reinforced insulation) if they are accessible to personnel.***
- ***If it is not possible to insulate the components as described above, the controller must be connected to a 24 V~ low voltage power supply (ensuring it is fully compliant with the safety standards).***
- ***The appliance must be connected to the electric mains via a switch capable of disconnecting all poles in compliance with the current safety standards and with a contact separation of at least 3 mm on all poles.***
- ***This appliance must be installed and wired by qualified technicians and in compliance with the current standards.***
- ***Make sure the mains power is off before wiring the appliance.***

## **ELECTRICAL CONNECTIONS**

The controller may be connected to either a 230 V~ or a 24 V~ power supply.

The controller is factory set at for a 230 V~ power supply, with the jumper in position JP1, at a frequency of 50Hz, with the jumper in position JP4. To select the 24 V~ supply option, move jumper JP1 (Fig. 6) to position JP2 (Fig. 6). To select the 60Hz frequency option, move jumper to JP4 (Fig. 6) to position JP3 (Fig. 6).

As shown in the wiring diagrams, the power supply terminals are designated L and N. Ensure the live and neutral lines are connected to the correct terminals when using a 230 V power supply. An input used for selecting centralised heating/cooling is available on terminal 3.

An input used for activating “economy” mode is available on terminal 4.

A window contact may be connected to terminals 14 and 16.

**N.B.:** *read the paragraph “ATTENTION” for the restrictions on the use of window contacts.*

The function associated with input terminals 3, 4 and 16 may be modified in parameters C17, C18 and C19. The signals to terminals 3 and 4 may also be connected to terminals 3 and 4 of other controllers in the same building (centralised Heating/Cooling function). The RS connector, or alternatively terminals 14 and 15, may be used to connect an external environmental temperature sensor. Change configuration to select the external or internal sensor. Terminals 13 and 14 constitute an input that may be used to connect different types of sensors for special functions: connect a supply temperature sensor for the “changeover” and/or “minimum temperature thermostat” function, or a bi-metal thermostat with “minimum temperature” function. Modify the configuration to select which type of sensor to use (P08). The device may be used to control both an electronic fan motor (EC motor) and a three speed fan motor. Use parameter P05 to define whether to use the 0-10V proportional output for an EC motor or the three relay outputs for a three speed motor. If the proportional output is used, the 0-10V signal will be available on terminal 11, with terminal 12 as the common connector. Connect the EC motor as shown in Fig. 13a. When using the three relay outputs for a three speeds motor, the outputs are available on terminals 6, 7 and 8, with terminal 5 as the common connector. Connect the three speed motor as shown in Fig. 13b. The fan motor outputs, terminals 5 to 8, are voltage free and isolated from the rest of the thermostat with reinforced insulation. This means that thermostat may be connected to a SELV low voltage (24 V~) power supply, but still used to control a high voltage fan (230 V~), as shown in Fig. 10. In this case, the 24 V~ SELV and 230 V~ cables must be separated in accordance with current standards. More specifically, it is necessary to secure the two groups of cables with cable ties so that the SELV wires are separate from the others. This ensures that the isolation of the SELV power supply is not compromised in the event a wire is disconnected by accident.

## **WARNING**

***This appliance must be installed and wired by qualified technicians and in compliance with the current standards.***

The device may be used to control one or two 0..10V proportional actuators or one or two ON/OFF actuators. The outputs for the ON/OFF actuators are only available when a proportional motor is used, i.e. when the relay outputs are not used to control the three speed motor. The heating 0..10V proportional output is available on terminal 9, while the cooling output is available on terminal 10, Fig.12d. In the case of two-pips systems, a single valve is used for both heating and cooling, so that the control signal corresponds to the heating signal available on terminal 9, Fig.12b. The common connector for all the 0..10V signals (valves and fan) is terminal 12. Please note that the ground is electrically connected to the power terminal Neutral 2. When connecting 24 V actuators, refer to the diagrams in Fig.9 and 10, while follow Fig. 8 refers to 230 V actuators. Usually 0..10V actuators only have 3 connection wires, as the input signal common is connected internally to one of the two power-supply wires (Neutral). In this case there is no need to connect terminal 12 (output signal common), as the actuator uses the Neutral power terminal for this purpose; make sure that this terminal is connected to terminal 2. When using ON/OFF valves, the heating output is available on



terminal 6 and the cooling output on terminal 7 Fig. 12c. In the case of two-pipe systems, only one valve needs to be connected to the heating output. Connect it as shown in Fig. 12a. It is possible to manage systems with two different kinds of valves for heating and cooling, for instance ON/OFF heating output and 0..10V proportional cooling output. If the system is equipped with an electric heater in addition to, or instead of the heating valve, connect according to the diagrams in Fig. 12e or Fig. 12f.

## TECHNICAL SPECIFICATIONS

Power supply:	24/230 V~ 50/60 Hz
Power consumption:	1.2 W
<b>Room temperature</b>	
Regulation range:	5°C .. 35°C (41°F .. 95 °F) configurable
Sensor type:	NTC 10kΩ @ 25°C (77 °F) ±1%
Precision:	± 1°C (± 1,8°F)
Resolution:	0.1°C (0.1°F <100°F)
Display range:	-10°C .. +50°C (14°F .. 122 °F)
Hysteresis:	adjustable 0.2°C (0.4°F)
<b>Supply water temperature</b>	
Sensor type:	NTC 10kΩ @ 25°C (77 °F) ±1%
Precision:	± 1°C (± 1,8°F)
Resolution:	± 1°C (± 1,8°F)
Display range:	0°C .. 99°C (32°F .. 210 °F)
Hysteresis:	2°C (4°F)
<b>Proportional outputs</b>	
Signal range:	0..10 V ===
Signal precision:	± 0.26 V ===
Minimum actuator impedance:	
1 x 0..10V output:	1850 Ohm
2 x 0..10V outputs:	3700 Ohm
3 x 0..10V outputs:	5550 Ohm
Relay contact capacity:	3 (1) A 250 V~
Remote probe (optional):	NTC 10kΩ @ 25°C (77 °F) ±1%
Protection rating:	IP 30
Type of action:	1
Voltage overload rating:	II

Pollution rating:	2
Tracking index (PTI):	175
Class of rating against electric shock:	II
Impulse withstand voltage:	2500V
Number of manual cycles:	50000
Number of automatic cycles:	100000
Software class:	A
EMC test voltage:	230 V~ 50 Hz
EMC test current:	34 mA
'Short' fault mode exclusion distance tolerance:	±0.15 mm
Ball pressure test temperature:	75°C (167°F)
Operating temperature:	0°C .. 40°C (32°F .. 104°F)
Storage temperature:	-10°C .. +50°C (14°F .. 122°F)
Humidity limits:	20% .. 80% RH (non-condensing)
Case:	
material:	ABS + PC V0 fire-retardant
colour:	Signal white (RAL 9003)
Dimensions:	132 x 87 x 23.6 mm (L x H x D)
Weight:	~ 265 g.

## CLASSIFICATION ACCORDING TO REG. 2013.811.EC

Class:	V
Energy efficiency contribution: 3%	3%



## HEATING/COOLING SELECTION

To select heating (winter) or cooling (summer) modes, press the  menu button for a few seconds, until one of the following messages appears on the display, indicating the currently selected status:

Heating mode (winter)

HEA : Cooling mode (summer)

CDD :

Next, press the ,  or  button to change the desired mode, cycling between heating and cooling. Pressing any of the other buttons confirms the selection and closes the menu.

When the controller is configured for automatic or centralised heating/cooling selection, it is not possible to change the selection manually changed and, if the user attempts to do so, the  flashing icon appears on the display.

## SUPPLY WATER INLET

This thermostat includes an input for the supply water temperature sensor: when this sensor is installed the device automatically determines whether it should be working in “cooling” mode or in “heating” mode: this function is called “water temperature changeover”.

This measurement is also to realise the “minimum temperature thermostat” function.

As an alternative to the supply water probe, it is also possible connect a bi-metal thermostat on this input in order to set-up the “minimum temperature thermostat” function.

### EXTERNAL INPUTS - TERMINALS 3, 4 AND 16

The thermostat also includes three external inputs that can be associated with a range of functions using parameters C17, C18 and C19.

The signals at terminals 3 and 4 may also be connected to terminals 3 and 4 of other controllers in the same building when installing centralised systems.

The signal at terminal 16 cannot be connected to other thermostats.

The functions that can be associated with the inputs are as follows:



#### **“Centralised Heating/Cooling” function:**

When installations include multiple thermostats in the same building, the centralised inputs of each thermostat may be connected together and controlled by the central heating room.

This permits the central heating room to determine whether the thermostats should be operating in heating or cooling mode.

#### **“Economy” function:**



This input activates/deactivates Economy mode (see the “Economy function” paragraph).

This function may be associated with the following icon: . The controller is sensitive to the changes in input state, not level, so it is always possible to change the economy status by pressing the  button (if enabled).

#### **“Stop regulation” function**

This input may be used to suspend or reactivate room temperature regulation.

When temperature regulation is suspended the fan is stopped, the valves remain closed and the respective symbols on the display flash.



This function may be associated with one of these icons:  or  or 

When an input is configured for the “stop regulation” function with the  icon, the “window contact” function is realised

If a window contact is connected to this input, when the window is open the  icon appears on the display and the temperature regulation function is suspended.

**N.B.:** *read the paragraph “ATTENTION” for the restrictions on the use of window contacts.*



#### **“Thermostat ON / OFF” function**

This input may be used to switch the thermostat on or off, as if the user had pressed the  button. The thermostat is sensitive to changes in input state, not level, which means it is always possible to modify its on/off state by pressing the  button (if enabled).

#### **“Motor alarm” function**

This input activates the  icon on the display. When the alarm is active, the electric heater output is disabled (if present).

#### **“Electric heater alarm” function**

When this alarm is activated, the  +  symbols flash on the display and the electric heater output is disabled (if present).

The heating element safety thermostat may be connected to this input.

#### **“Dirty filter warning” function**

This input activates the dirty filter warning, the  filter icon flashes on the display.

#### **“Motor rpm control” function**

This function is used to monitor the fan rotation by measuring the motor rpm.

The function may only be configured on input 16. The motor rpm sensor must be connected to terminal 16. When the fan is on, the thermostat checks that the motor is running and is not jammed, verifying that the signal frequency is between 1 and 255 commutations per second. In the event of an error, the  icon appears on the display and the electric heater output is disabled (if present).

### **OUTPUT 8**

The thermostat may be used to drive output 8 in order to set-up one of the special functions listed in table 6, which are configured using parameter C23. Output 8 is not available when using the three relays to drive a three speed fan or when configuring an “integrated heating element system”. The following functions may be set-up:

#### **Fan logic**

This output is active when the proportional fan is on, regardless of the speed.

#### **Valve logic**

This output is active when the valve is open. In case of 4 pipe systems, this output is active when one of the two valves is open.

**ON/OFF logic**

This output is active when the thermostat is on.

**Economy logic**

This output is active when the thermostat is in economy mode or switched off.

**Heating/cooling logic**



This output is active when the thermostat is in heating (winter) mode.

**Input status repetition**

This output repeats the status of an input 3, 4 or 16. This output is active when the inlet is closed.

**0..10V PROPORTIONAL OUTPUTS CONTROL**

It is possible to connect several actuators to the same 0..10V output, however it is necessary to make sure the output is not overloaded. Ensure that the impedance of the group of actuators does not drop below the minimum impedance the thermostat is capable of driving (see “Technical specifications” section).

The thermostat monitors the 0..10V outputs continuously and, if it detects an overload, it indicates the anomaly on the display by activating the  icon in the event of a problem on a heating or cooling 0..10V valve output, or the  icon in the event of a problem on the 0..10V fan output. In the case of a problem on the fan output, the electric heater output is disabled in electric heater and integrated electric heater systems.

**TEMPERATURE ACQUISITION**

The thermostat acquires both the room temperature and the delivery water temperature in the fan-coil exchanger via NTC type sensors. The thermostat is equipped with an internal temperature sensor, as well as an input for a remote sensor. To select the internal or remote sensor, access parameter P11 in the “installer configuration”. The supply water temperature in the fan-coil is acquired via a remote NTC sensor. There is no need to install the supply water sensor if the system does not require it. To enable the functions associated with the supply water sensor, refer to the “Cut-off temperature function” section. If the room or water temperature is outside the operating range, the display indicates “Or” (out of range). In the event of a sensor fault, such as an open or a short circuit, the display indicates “EEE” (error): when this happens, the functions that require the temperature reading are not performed.

**MINIMUM TEMPERATURE THERMOSTAT FUNCTION**

The minimum temperature thermostat function is used to inhibit fan operation if the supply water is not hot enough when the system is in heating mode. To set-up this function, a supply water temperature probe, or a bi-metallic thermostat, must be installed on the terminals.

When using probe, the “water hot enough/not hot enough” threshold is defined in parameter P23. If this function is not required, parameter P23 can be set to a very low value.

When using a bi-metal thermostat for this function, parameter P08 must be set to the value “2”: in this case, fan operation is enabled only when the bi-metal contact is closed. When using this type of bi-metal thermostat, it is not possible to display the water temperature or execute the automatic changeover function. Please refer to the “Installer Configuration” section for information on setting up the parameters related to the functions described above. The “minimum temperature thermostat” function is also available in cooling mode. In this case, fan operation is inhibited when the supply

water is not cold enough, according to the threshold defined in parameter P24. If this function is not required, parameter P24 can be set to a very high value.

When the delivery water temperature is not hot or cold enough, as per the P23 and P24 thresholds, the  icon is displayed. The fan is inhibited and the fan speed symbols flash.

## SYSTEM WITH HEATING ELEMENT

The thermostat can be configured (P01=2) to control a system that includes an electrical heating element for heating the room and a cooling water regulator valve for cooling the room.

Refer to the wiring diagram in Fig. 12e and Fig. 12f.

When installing this type of system, we recommend setting up a fan switch-off delay interval in P22, so that when the electric heater is switched off, the fan keeps running to cool the heater down. When the fan motor is driven in proportional mode, in order to cool the heater, it is possible to set-up a minimum speed in parameter C14, which is maintained while the electric heater is on. In this type of system it is possible to set-up a regulation with neutral zone by enabling the automatic heating/cooling select function (P02=1). When using the “minimum temperature thermostat” function with this type of system, the fan is never inhibited while in heating mode.

## SYSTEM WITH INTEGRATED HEATING ELEMENT

The thermostat can be configured (P01=3) to manage systems that feature two different ambient heating systems: one with a hot water flow controlled by a valve, the other with an integrated electric heating element. In this mode, the thermostat drives a single valve on the outlet of the cooling valve and an integrated heating element on the outlet of the heating valve. See Fig. 12e and Fig. 12f for the respective wiring diagrams. The valve is driven as in a two pipe system: the flow of hot or cool water being managed according to the heating or cooling setting of the thermostat. The electric heater is activated as an additional (integrated) heat source in heating mode if the room temperature falls below the set point temperature by a value  $\Delta$ , which can be configured in parameter C21. In cooling mode, it is possible to set-up a regulation with neutral zone by setting the amplitude of the neutral zone to a value greater than zero in P20. In this case, cooling is achieved by activating the valve, and heating by activating the electric heating element.

When installing this type of system, we recommend setting up a fan switch-off delay interval in P22, so that when the electric heater is switched off, the fan keeps running to cool the heater down. When the fan motor is driven in proportional mode, in order to cool the heater, it is possible to set-up a minimum speed in parameter C14, which is maintained while the electric heater is on.

When using the “minimum temperature thermostat” function with this type of system, the fan is never inhibited while in heating mode, as the electric heating element is switched on in advance.

## UNDERFLOOR FAN COIL HEATING AND COOLING SYSTEMS

The thermostat can be configured to manage a special system that employs different temperature conditioning methods, depending on whether it is necessary to heat or cool the room.

For example, during summer the thermostat may be used to drive a fan coil, cooling the room by controlling the fan and the cold valve, while in winter, it may be used to control the underfloor heating valve while maintaining the fan coil fan off.



The thermostat can receive information on the summer/winter status directly from the heating system via 3 or 4, so that it manages the seasonal changeover automatically, by calling up the climate mode and set-point for the respective seasons automatically. To configure this type of system, set P01=1 and P03=4.

## ECONOMY FUNCTION

The “Economy” function may be used to activate a temporary energy saving mode by reducing the current set-point temperature by a single (configurable) step when in heating mode, or increasing it by the same step when in cooling mode. The value of this reduction step may be set-up in parameter P18: when this value is set to 0.0, the Economy function is disabled.



To activate Economy mode, press the  button, see “Description of commands”.

The Economy mode function can also be activate remotely in centralised mode, even when using multiple thermostats, via the inputs ton terminals 3 or 4 (see parameters C17 and C18).

Since the thermostat is sensitive to changes in the signal status, and not level, use the  button to change the activation status of the Economy function, even when forced by the centralised signal. When the Economy function is active ( icon on), the fan speed is limited to the first speed or the value set-up in parameter C11 for proportionally controlled fans.

## DIRTY FILTER WARNING FUNCTION

Fan-coils, and other devices that include a fan, are often equipped with an air inlet filter, which must be cleaned at regular intervals. This thermostat notifies the user when it is necessary to clean the filter by activating the “Dirty filter warning” function.

This function is activated by setting up the time-to-maintenance value in parameter P25. The thermostat monitors the fan operating time and, when it reaches the threshold set in P25, the  filter icon flashes on the display. Once the filter has been cleaned, to reset the warning and the time counter press the  button for 10 seconds, until the  filter icon disappears from the display.

## TEMPERATURE REGULATION

This thermostat may be used to drive both the valves and the fan in proportional mode so as to regulate the room temperature for maximum comfort and energy saving. It is, however, necessary set-up some parameters differently for each individual environment in order to achieve more precise regulation.

The parameters responsible the quality of the regulation are as follows:

- Proportional band: C03 and C04
- Integration time: C05 and C06

There are two parameters are available for both settings so that the user can set-up different values for heating and cooling mode. The proportional band, expressed in °C or °F, represents the difference between the set-point value and room temperature that ensures the valve is fully opened by the regulator and/or switches the fan on at maximum speed. The narrower the proportional band, the more rapidly the system reacts to variations in the room temperature. If the proportional band is too “narrow”, it may cause the room temperature to oscillate, or system instability. If this value is too “wide”, on the other hand, it may be impossible to reach the set-point temperature. If the integration time is set to zero, no integral action implemented, meaning that the regulation is purely proportional (P type). When the integration time is set to a value other than zero, P+I (Proportional



+ Integral) regulation is implemented. The smaller the integration time, the greater the influence of the integral action and, vice-versa, the greater integration time the lesser the effect of the integral action. If the integral is weak or absent, it may not be possible to reach the set-point temperature in the controlled environment. If the integral action is too strong, it may cause the room temperature to oscillate. It is necessary to adjust these parameters according to the actual environment where the system is installed in order to achieve the best regulation accuracy.



Proportional control of the valves is only possible when they are driven by the 0..10V outputs. Proportional control is not possible when using ON/OFF valves, as they will either be always ON or always OFF, with a hysteresis value set-up in parameter P19.





The fan may be driven proportionally only when it is in automatic speed mode. The fan speed are regulated proportionally (P + I) even when using a three speed fan motor.

The space between the three speed stages is calculated dividing the proportional band by three and rounding down. For example, if the proportional band is set to 2°C (35.6 °F), the space between stages will be 0.6°C (33.08 °F).

## INSTALLER CONFIGURATION

The installer configuration defines how the thermostat functions and may be used to adapt it to the different types of environments and systems. To access the configuration menu, press the  and  buttons simultaneously for a few seconds until “Con” (configuration) appears on the screen.

At this point, press the  button to scroll through the various parameters, identified by a P and the respective parameter number, from P01 to P25. Once configuration is complete, the message “End” appears on the display. At this point, press the  button to save the configuration and restore normal thermostat operation.

Press the  button at any moment to close the configuration menu without saving the modifications. When scrolling the parameters press the ,  or  button to display the current value.

To change the value, of the currently displayed parameter, press the  or  button.

To prevent unauthorised personnel from accessing the configuration, remove the internal jumper (JP5) as indicated in Fig. 6 so that the  icon flashes on the display if anyone attempts to access the configuration settings.

The installer configuration consists of two lists of parameters:





- main parameters P01 to P25 (table 1)
- extended parameters C01 to C23 (table 2)

The extended parameters C01-C01-C23 are used for the advanced thermostat settings.

When the display shows “Con” at the start of the configuration procedure or “End” upon completion, press the  button to access the extended parameters.



## RESET INSTALLER CONFIGURATION

In order to reset the installer configuration, so that all parameters are restored to the factory default values, access configuration mode by pressing the  and  buttons until the message “Con” is displayed, and then press the  and  buttons for a few seconds, until the display reverts to the usual screen.

## DESCRIPTION OF MAIN CONFIGURATION PARAMETERS

The main installer configuration parameters are shown in table 1 and explained below.

### **P01: Select system type.**

#### ***2-pipe system:***

when configured for a 2 pipe system, the thermostat drives a single valve at the output of the heating valve, in both heating and cooling mode, since the same valve is used to control both hot and cold water.

See Fig. 12a and Fig. 12b for the respective wiring diagrams.

In case of a 2 pipe system without a valve, and therefore without connections on the valve output, for effective regulation parameters P03 and P04 should be set to “fan control”.

#### ***4-pipe system:***

when configured for a 4 pipe system, the thermostat drives both valve outputs, so as to activate either the hot or cold water flow depending on the current requirements of the controlled environment.

See Fig. 12c and Fig. 12d for the respective wiring diagrams.

#### ***System with heating element:***

the regulator is configured to control a system equipped with an electric heating element for heating the room, see the section “System with heating element” for more details.

#### ***System with integrated heating element:***

the regulator is configured to control a system equipped with an integrated heating resistance: see the section “System with integrated electric heating element” for more details.

### **P02: This parameter defines how the controller switches from cooling (summer) to the heating (winter) mode and vice versa.**

Switching may be either manual or automatic:

#### ***Manual:***

The user selects heating or cooling mode manually.

#### ***Automatic:***

The thermostat switches automatically from the heating to cooling mode or vice-versa.

This automatic operation varies depending on the system type selected in P01.

In case of a 4 pipe systems or systems with a heating element, the thermostat operates with a neutral zone, so that it activates heating or cooling depending on the set-point temperature.

In case of a 2 pipe systems or a systems with an integrated heating element, the thermostat executes the changeover depending on the supply water temperature. When the supply water temperature is low (i.e. below the threshold defined in parameter C01), the thermostat switches to cooling mode. On the other hand, when this temperature is high (i.e. above the threshold defined in parameter C02), the thermostat switches to heating mode.

When the supply water temperature is neither too low nor too high, the operating mode remains the same, and may be manually changed.

When the supply water sensor is not installed, or is not properly working, the automatic selection function is disabled and only manual switching is permitted.

### **Centralised:**

When installations include multiple thermostats in the same building, the centralised inputs of each thermostat may be connected together and controlled by the central heating room.

Parameters C17, C18 and C19 may be used to select the input and the mode (normal or reversed) to be associated with the "centralised summer/winter mode" function.

The wiring diagrams include an example of the wiring connections to the centralised input.

### **P03 and P04: These parameters define which outputs are regulated.**

Parameter P03 is used in heating mode, and parameter P04 in cooling, so it is possible to select different temperature conditioning methods, depending on the season. Each parameter defines whether the thermostat should regulate the temperature by acting on the valve, on the fan or on both. If the user decides to regulate the temperature using the valve only, the fan will continue running even after temperature has reached the set-point, alternatively, the user may choose to disable the fan permanently. If the user decides to regulate the temperature using the fan only, the valve will remain open even after the temperature has reached the set-point, alternatively, the user may choose to keep the valve closed permanently. In systems with an integrated heating element, these parameters may not be used to inhibit the regulation of the valve outputs since they are driven according to the specific system type.

### **P05: This parameter informs the thermostat which kind of fan motor it has to drive: an EC motor on the 0-10V proportional output or a three-speed fan motor on the three relay outputs.**

Also, it is possible to invert the proportional fan output, similarly to the valve outputs, so that the 0 V signal switches the motor on at maximum power and the 10 V signal switches it off.

### **P06 and P07: These parameters inform the controller which kind of valve is to be wired to the heating output and the cooling output, respectively.**

The controller can be configured to drive NO or NC (normally open or normally closed) ON/OFF valves or 0..10V proportional valves. In the case of 0..10V proportional valves, it is possible to set-up the following type of action:

Direct action: this means that the thermostat generates a 0 V signal at the output to close the valve and 10 V to open it.

Inverse action: this means that the thermostat generates a 10 V signal at the output to close the valve and 0 V to open it.

### **P08: This parameter informs the thermostat which type of probe is to be connected to the supply water input (terminals 13 and 14).**

The values 0 and 1 indicate that it should acquire the temperature reading from a supply water probe. It is also possible to define whether the thermostat should display the supply water temperature or not, since the supply water probe may or may not be connected, depending on the system requirements. When it is connected, the thermostat acquires and uses the information provided by the water supply probe, even if the user decides not to display the temperature reading. Set this parameter to 2 to inform the device that the supply inlet is to be fitted with bi-metal thermostat, which will be used exclusively for the minimum temperature thermostat function in heating mode.

**P09: This parameter maybe used to enable the room air “de-stratification” function in the controlled environments.**

This function intervenes when the fan is switched off, switching it on at low speed for 1.5 minutes once every 15 minutes, irrespective of the state of the thermostat.

**P10: In the event of a black-out, the thermostat remembers its most recent state and, when power is restored, it restarts with the same settings (on/off, heating/cooling, etc.).**

However, in certain situations, it may be necessary to restart the thermostat in a known state (i.e. always OFF or always ON).

To do this, set parameter P10 to “2” (always “ON”) or “3” (always “OFF”).

**P11: Select room temperature sensor.**

This parameter defines whether the internal temperature probe is used to acquire the room temperature or the (optional) external one.

**P12: This parameter may be used to correct the acquired room temperature reading.**

In fact, in some installations, due to the location of the sensor (either internal or external), the temperature reading may not be accurate.

By changing the value of this parameter the reading, since the selected value is summed with the acquired room temperature value.

**P13 and P14: These two parameters may be used to set the range of the set-point temperature in heating mode.**

More specifically, P13 corresponds to the lower limit, while P14 corresponds to the upper limit.

**P15 and P16: These two parameters may be used to set the range of the set-point temperature in cooling mode, according to the same logic as the two previous points.**

When switching between heating/cooling mode, the set-point temperature are automatically modified accordingly. If the thermostat is configured to regulate with a neutral zone, these two parameters are disregarded and the settings of parameters P13 and P14 are used.

**P17: This parameter defines an anti-freeze temperature, i.e. a minimum temperature that is maintained in the room, even when the thermostat is switched off by means of the on/off switch.**

Regulation at this temperature only occurs when the thermostat is set to heating mode; the fan speed is limited to the lowest setting. Set the parameter to 0.0°C (32°F) to disable the anti-freeze function.

**P18: This value defines the temperature reduction step (in °C or °F) used to implement the “Economy” function.**

The current set-point is reduced in heating mode or increased in cooling mode by a value corresponding to this step when the “Economy” function is made active. Set this parameter to 0.0 to disable “Economy” function permanently.

**P19:** This parameter sets the hysteresis value (in °C or °F) applied when driving the on-off outputs in response to variations in the room temperature.

**P20:** If the thermostat is configured to operate with a neutral zone, this parameter determines the amplitude of the neutral zone. This value is assumed to be central with respect to the set-point temperature.

**P21:** This parameter may be used to define a delay time (in seconds) between the moment the fan is switched on and the moment the valve is opened, so as to allow sufficient time for the heat exchanger to heat up or cool down.

**P22:** This parameter may be used to define a delay time (in seconds) between the moment the fan is switched on and the moment the valve is closed, so as to allow sufficient time for the heat exchanger or heating element to dissipate all its heat.

**P23:** This parameter defines the threshold above which the supply water is considered sufficiently hot to implement the “minimum temperature thermostat” function in heating mode. If this function is not required, set this parameter to zero.

**P24:** This parameter defines the threshold below which the supply water is considered sufficiently cold to implement the “minimum temperature thermostat” function in cooling mode. If this function is not required, set this parameter to 99.

**P25:** This parameter defines the “Dirty filter warning” interval and may be set to any value between 0 and 50 x 100 h, in other words, if the value is set to 10, the warning will be generated after 1000 hours.

Set the value to 0 to disable the “Dirty filter warning”.

## DESCRIPTION OF EXTENDED CONFIGURATION PARAMETERS

The extended installer configuration parameters are shown in table 2 and explained below.

**C01 and C02:** These parameters define the thresholds for the automatic changeover function: if the function is not used this information is not applied.

The C01 parameter corresponds to the lower threshold, while C02 corresponds to the upper threshold.

**C03 and C04:** These parameters may be used to define the amplitude of the proportional band, in heating and cooling mode respectively.

The parameters can be set to a value within the range shown in table 2, however, due to the hysteresis value set-up in P19, the lower limit may be higher, since the two parameters interact.

**C05 and C06:** These parameters may be used to set the integral regulation time in heating and in cooling mode respectively.

If these values are set to zero, no integral action is implemented.

**C7 and C8: these two parameters correspond to the minimum power percentage of the proportional heating and cooling valve respectively.**

The minimum power corresponds to the minimum proportional valve opening percentage, below which the fan remains disabled so that it is not switched on before the valve has started to open the flow of water.

**C09: This parameter may be used to define the number of speeds of the fan motor used in the system.**

Typically, fans are driven by three speed type motors, but this parameter may also be used to manage 1 or 2 speed motors.

**C10: This parameter may be used to define which fan speeds can be selected using the “fan” button.**

In certain installations it may be necessary to limit the function of the  button.

Table 3 lists the permitted combinations.

**C11, C12 and C13: When the fan is driven via the proportional output, these parameters define the speeds associated with the fixed speed settings 1, 2 and 3.**

The parameters are expressed as a % of the maximum fan coil speed, as defined in C16.

These parameters are not used if the fan is controlled via the relays.

**C14: When the fan is driven via the proportional output, this parameter defines the minimum speed that should be maintained when the electric heater is on in an electric heater system (P01=2 or 3).**

The parameter is expressed as a % of the maximum fan coil speed, as defined in C16.

**C15 and C16: These parameters correspond to the lower and upper limit of the fan proportional output signal.**

The parameters may be modified within the range 0.0 ..10.0 V.

These parameters may be used to customise the output voltage, which may be useful for limiting the minimum and maximum speed of the fan motor.

**C17, C18 and C19: These parameters may be used to select which function to associate with inputs 3, 4 and 16 .**

Table 4 lists the functions that can be associated with each input. The installer is responsible for ensuring that no function is associated with more than one input. See the “External inputs - terminals 3, 4 and 16” section for further information.

**C20: This parameter may be used to define which operating modes can be selected by pressing the  button.**

In certain installations it may be necessary to limit the function of the  button. Table 5 lists the permitted combinations.

**C21: This parameter may be used to configure the integration “ set point” for the integrated heating element system.**

See the “Integrated heating element system” section for further information.

**C22: If the buttons are not pressed for a few seconds, the thermostat reverts to displaying the room temperature.**

When this parameter is set to 1, the thermostat displays the set-point temperature instead of the room temperature.

**C23: This parameter is used to inform the thermostat which function should be implemented on output 8.**

Table 6 lists the functions that can be implemented.

See section "Output 8" for more information.

## CORRECT ROOM TEMPERATURE MEASUREMENT

To ensure the system measures the room temperature correctly, it is necessary to take the following into account.

- To ensure the temperature is acquired correctly, the thermostat should be installed where it is not exposed to from heat sources, air flows or cold walls (thermal bridges). When using the remote temperature probe in conjunction with the thermostat, this applies to the probe rather than the thermostat itself.
- When using a remote temperature probe, avoid routing the signal wires and power (mains) cables via the same conduit as this could compromise the accuracy of the temperature readings. If necessary, use bipolar screened cable, connecting the screen to earth on the thermostat only (terminal 14). The cable should have a minimum cross section of 1.5 mm<sup>2</sup> and not exceed 15 m in length.
- During normal operation with the internal sensor, the thermostat conditions the acquired signal by means of a special algorithm that has been designed to compensate for the heat generated by its internal components. For this reason, the temperature value displayed when the device is switched on may be lower than the real temperature. This effect is entirely normal and disappears completely within a few minutes.
- In the thermostat outputs are used to drive large loads (where the current is close to the maximum rated value) the heat generated by the internal components may increase. This temperature increase may also affect the acquired room temperature value, if measured using the internal probe. This problem is not present when using the remote temperature probe.
- If the acquired room temperature reading is considered unsatisfactory for any reason, it may be corrected by modifying parameter P12.
- When the thermostat is connected to a 230 V~power supply, it is essential that the live and neutral (L + N) are respected when making the electrical connections.

**Table 1: Main configuration parameters**



DFLT	PAR.	DESCRIPTION	PERMITTED VALUES				
0	P01	System type	0 2-pipe system	1 4-pipe system	2 Heating element	3 Integrated heating element	-
0	P02	Select summer/winter	0 Manual	1 Automatic	2 Centralised	-	-

DFLT	PAR.	DESCRIPTION	PERMITTED VALUES				
<i>3</i>	<i>P03</i>	Regulate heating	<i>1</i> Fan always ON	<i>2</i> Valve always ON	<i>3</i> Valves and fan	<i>4</i> Fan always OFF	<i>5</i> Valve always OFF
<i>3</i>	<i>P04</i>	Regulate cooling	<i>1</i> Fan always ON	<i>2</i> Valve always ON	<i>3</i> Valves and fan	<i>4</i> Fan always OFF	<i>5</i> Valve always OFF
<i>0</i>	<i>P05</i>	Fan output type	<i>0</i> Proportional, direct action	<i>1</i> Proportional, inverse action	<i>2</i> 3 speed relays	-	-
<i>2</i>	<i>P06</i>	Heating output type	<i>0</i> Proportional, direct action	<i>1</i> Proportional, inverse action	<i>2</i> NCON/OFF valve	<i>3</i> NO ON/OFF valve	-
<i>2</i>	<i>P07</i>	Cooling output type	<i>0</i> Proportional, direct action	<i>1</i> Proportional, inverse action	<i>2</i> NCON/OFF valve	<i>3</i> NO ON/OFF valve	-
<i>0</i>	<i>P08</i>	Supply water inlet	<i>0</i> Do display temperature	<i>1</i> Display temperature	<i>2</i> Bi-metal contact	-	-
<i>0</i>	<i>P09</i>	De-stratification	<i>0</i> Never	<i>1</i> During cooling	<i>2</i> During heating	<i>3</i> Always	-
<i>1</i>	<i>P10</i>	On/Off state at power up	-	<i>1</i> Previous	<i>2</i> Predefined ON	<i>3</i> Predefined OFF	-
<i>0</i>	<i>P11</i>	Room sensor	<i>0</i> Internal	<i>1</i> External	-	-	-

DFLT	PAR.	DESCRIPTION	PERMITTED VALUES
<i>0.0</i>	<i>P12</i>	Room temperature offset (°C)	<i>-10.0 .. 10.0</i>
<i>10.0</i>	<i>P13</i>	Temp. Winter set-point lower limit (°C)	<i>5.0 .. 35.0</i>
<i>30.0</i>	<i>P14</i>	Temp. Winter set-point upper limit (°C)	<i>5.0 .. 35.0</i>
<i>10.0</i>	<i>P15</i>	Temp. Summer set-point lower limit (°C)	<i>5.0 .. 35.0</i>
<i>30.0</i>	<i>P16</i>	Temp. Summer set-point upper limit (°C)	<i>5.0 .. 35.0</i>
<i>0.0</i>	<i>P17</i>	Anti-freeze threshold temperature (°C)	<i>0.0 .. 15.0</i>
<i>0.0</i>	<i>P18</i>	Economy reduction (°C)	<i>0.0 .. 10.0</i>
<i>0.2</i>	<i>P19</i>	Room temperature hysteresis (°C)	<i>0.2 .. 1.0</i>
<i>3.0</i>	<i>P20</i>	Neutral zone amplitude (°C)	<i>0.0 .. 11.0</i>

DFLT	PAR.	DESCRIPTION	PERMITTED VALUES
0	P21	Fan start delay (seconds)	0 .. 600
0	P22	Fan stop delay (seconds)	0 .. 600
40	P23	Winter supply water temperature threshold (°C)	0 .. 99
15	P24	Summer supply water temperature threshold (°C)	0 .. 99
0	P25	Dirty filter warning interval (x 100 hours)	0 .. 50

**Table 2: Extended configuration parameters.**











DFLT	PAR.	DESCRIPTION	PERMITTED VALUES
17	C01	Lower changeover threshold (°C)	0 .. 24
30	C02	Upper changeover threshold (°C)	26 .. 48
2.0	C03	Heating proportional band (°C)	08 .. 8.0
2.0	C04	Cooling proportional band (°C)	08 .. 8.0
0	C05	Supplementary heating interval (minutes)	0 .. 60
0	C06	Supplementary cooling interval (minutes)	0 .. 60
20	C07	Heating valve minimum power (%)	0 .. 50
0	C08	Cooling valve minimum power (%)	0 .. 50
3	C09	Fan motor speed number	1.. 3
0	C 10	Fan speeds selectable by pressing button 	0 .. 15
33	C 11	Minimum fan power (%)	1.. 100
66	C 12	Medium fan power (%)	1.. 100
100	C 13	Maximum fan power (%)	1.. 100
50	C 14	Minimum fan power heating element active (%)	0 .. 100
0.0	C 15	Lower fan signal limit (V)	0 .. 10.0
10.0	C 16	Upper fan signal limit (V)	0 .. 10.0
1	C 17	Function associated with terminal 3 input	0 .. 22
3	C 18	Function associated with terminal 4 input	0 .. 22
9	C 19	Function associated with terminal 16 input	0 .. 23
0	C20	Modes selectable by pressing button 	0 .. 7
1.5	C21	 integrated heating element set-point (°C)	0.0 .. 20.0
0	C22	Default view	0 Room temperature 1 Set-point temperature
0	C23	Type of output 8	0 .. 16











**Table 3: Parameter C10 - Select fan speeds - to set-up the speeds, press button .**

VALUE	DESCRIPTION	VALUE	DESCRIPTION
0	1 -> 2 -> 3 -> AUTO	8	1
1	1 -> 2 -> AUTO	9	2
2	1 -> AUTO	10	3
3	OFF -> 1 -> 2 -> 3 -> AUTO	11	AUTO
4	OFF -> 1 -> 2 -> AUTO	12	1 -> 2 -> 3
5	OFF -> 1 -> AUTO	13	1 -> 2
6	OFF -> 1	14	OFF -> 1 -> 2 -> 3
7	OFF	15	OFF -> 1 -> 2

**Table 4: PARAMETERS C17, C18, C19 - Function that may be associated with inputs 3, 4 and 16.**

VALUE	DESCRIPTION
0	No function associated.
1	"Centralised Summer/Winter" function (closed contact = summer); the parameter P02 must be set to 2.
2	"Inverted centralised Summer/Winter" function (closed contact = winter); the parameter P02 must be set to 2.
3	"Economy" function (closed contact = reduction).
4	"Economy" function (closed contact = reduction) - the  (present) or  (absent) icon appears on the display.
5	"Inverted economy" function (contact open = reduction).
6	"Inverted economy" function (contact open = reduction) - the  (present) or  (absent) icon appears on the display.
7	"Stop regulation" function (closed contact = stop regulation)
8	"Stop regulation" function (contact closed = stop regulation) - the  (present) or  (absent) icon appears on the display.
9	"Stop regulation" function (contact closed = stop regulation) - the  icon appears on the display.
10	"Stop regulation" function (contact closed = stop regulation) - the  icon appears on the display.
11	Inverted "Stop regulation" function (contact open = stop regulation).
12	Inverted "Stop regulation" function (contact open = stop regulation) - the  (present) or  (absent) icon appears on the display.
13	Inverted "Stop adjustment" function (open contact = stop adjustment) the  icon appears on the display.

VALUE	DESCRIPTION
14	Inverted "Stop adjustment" function (open contact = stop adjustment) the  icon appears on the display.
15	"Thermostat ON / OFF" function (contact closed = thermostat off).
16	Inverted "thermostat ON / OFF" function (contact closed = thermostat on).
17	"Motor alarm" function (contact open = alarm) - the  icon appears on the display.
18	Inverted "Motor alarm" function (contact open = alarm) - the  icon appears on the display.
19	Heating element alarm (contact closed = alarm,  +  icons flash on the display).
20	Inverted heating element alarm (contact open = alarm,  +  icons flash on the display).
21	Dirty filter warning: contact closed = dirty filter icon  flashing.
22	Inverted dirty filter warning: contact open = dirty filter icon  flashing.
23	Motor rpm control input (valid for input 16 only).

**Table 5: Parameter C20 - Select operating modes - to set-up, press button **

VALUE	DESCRIPTION
0	OFF -> ON -> RDC
1	OFF -> ON
2	OFF -> RDC
3	OFF
4	ON -> RDC
5	ON
6	RDC
7	No function

**Table 6: Parameter C23 - Output 8 function.**

VALUE	DESCRIPTION
<i>0</i>	No function
<i>1</i>	Fan logic; relay closed when the proportional fan is on.
<i>2</i>	Inverted fan logic; relay closed when the proportional fan is off.
<i>3</i>	Valve logic; relay closed when the valve is open.
<i>4</i>	Inverted valve logic; relay closed when the valve is closed.
<i>5</i>	ON/OFF logic; the output is active when the thermostat is on.
<i>6</i>	Inverted ON/OFF logic; the output is active when the thermostat is off.
<i>7</i>	Economy logic; the output is active when the thermostat is in economy mode or off.
<i>8</i>	Inverted Economy logic; the output is active when the thermostat is on and NOT in economy mode.
<i>9</i>	Summer/Winter logic; the output is active when the thermostat is in heating (winter) mode.
<i>10</i>	Inverted Summer/Winter logic; the output is active when the thermostat is in cooling (summer) mode.
<i>11</i>	Duplicate input 3; this output is active when input 3 is closed.
<i>12</i>	Inverted duplicate input 3; this output is active when input 3 is open.
<i>13</i>	Duplicate input 4; this output is active when input 4 is closed.
<i>14</i>	Inverted duplicate input 4; this output is active when input 4 is open.
<i>15</i>	Duplicate input 16; this output is active when input 16 is closed.
<i>16</i>	Inverted duplicate input 16; this output is active when input 16 is open.

# WIRING DIAGRAM

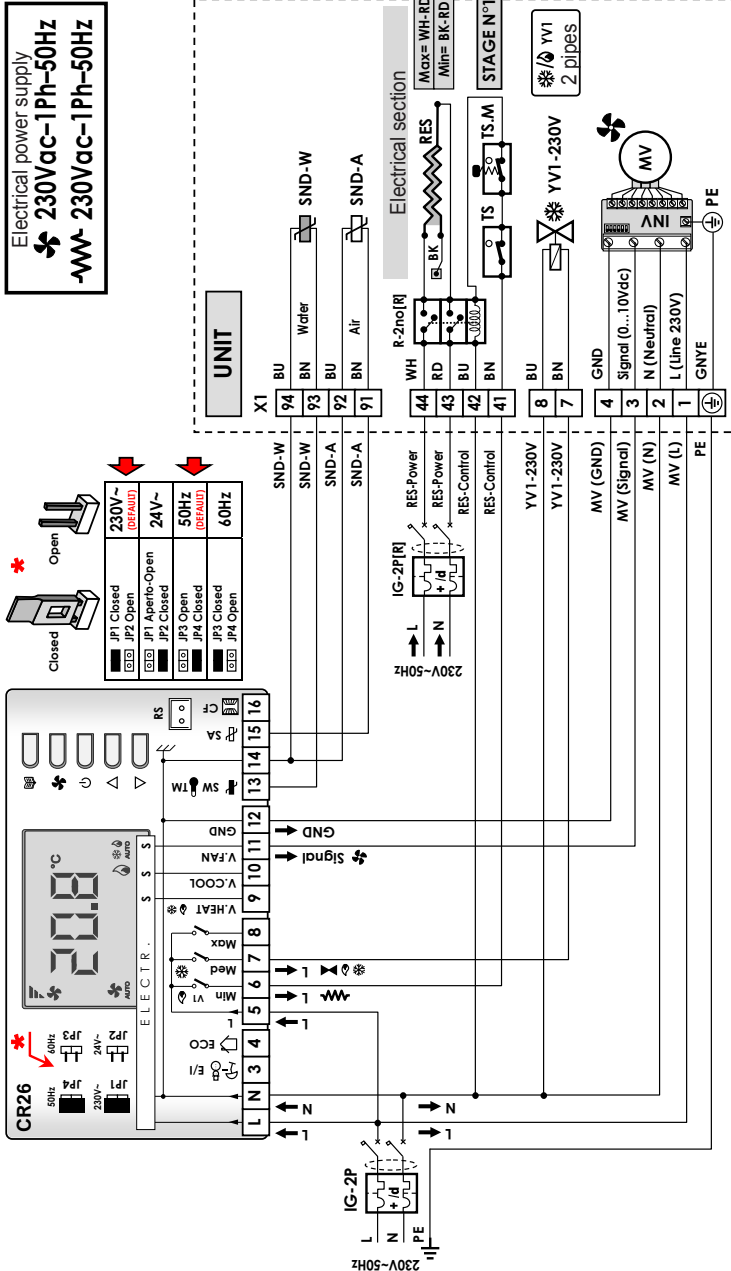

**WARNING**

- **THE USER MUST SET-UP THE REGULATOR ACCORDING TO HIS/HER REQUIREMENTS**
- **IT IS OBLIGATORY TO REFER TO THE REGULATOR MANUAL**
- **RES- OBLIGATORY: POST-VENTILATION**
- **RES- OBLIGATORY: AIR SPEED > 1 m/s**
- **See the notes on the RES electrical section circuit diagram.**

**Legend**

REF.	DESCRIPTION
L	Phase (line 230 Vac - 1ph)
N	Neutral
PE	EARTH
GYNE	Yellow/green
BN	Brown
BU	Blue
BK	Black
RD	Red
WH	White
GY	Grey
VT	Violet
OG	Orange
1,2...; a,b...; etc.:	Markings that appear on the terminal boards and electrical devices
<b>STANDARD COMPONENTS SUPPLIED ALREADY MOUNTED</b>	
MV	EC (or Brushless) electronic fan motor: power supply 230 Vac, signal 0...10 Vdc GND = Signal reference GND Signal = Control signal (0...10 Vdc)
INV	EC electronic motor inverter (or Driver)
X1	Unit electrical terminal board (with user side terminals)
<b>ACCESSORIES (present only if requested/ordered)</b>	
YV1-230V	Main heat exchanger valve 230 V on/off (2 pipes = cold/hot; 4 pipes = cold)
RES	Electric heating element 230 Vac; 2 states (RD = Common; BK = Low Power; WH = High Power): ▶ "RD-BK" cables connection: Lower power ▶ "RD-WH" cables connection: Higher power The 2 "WH" - "BK" electrical heating element cables may be connected differently with respect to the indications on the electrical circuit diagram (depending on the model).
TS	Self-rearming safety thermostat (1 ST always fitted for each state)

REF.	DESCRIPTION
TS.M	Manually re-armed safety thermostat (only upon request)
R-2no[R]	Dual NO contact relay (NO = normally open), with 230 Vac coil
SND-A	Air temperature probe
SND-W	Water temperature probe
	<b>COMPONENTS TO BE SUPPLIED BY THE CUSTOMER; (opp. Components supplied loose (accessories supplied only if requested/ordered))</b>
CR26	Remote command (Regulator)
IG-2p	Main differential thermo-magnetic circuit breaker (230 Vac, 2 contacts: Phase, Neutral)
IG-2p[R]	Main thermo-magnetic circuit breaker (+ differential if ordered), (230 vac, 2 Poles: Phase + Neutral)

***N.B.: The electrical system components (IG-2P, etc.) must be selected according to the power consumption of the unit (or section/component) it is required to supply.***

The electrical system must be installed by a qualified technician, in accordance with all the applicable standards and regulations. The system must be developed with the assistance of a professional designer and realised using top quality, certified components that are suited to the specifics of the system where they are to be installed, and compatible with the specifications of the components mounted on the unit/accessory it is used to supply. The system must be fitted with a suitable, single-pole, differential, thermo-magnetic circuit breaker capable of providing adequate overload (thermal), short-circuit (magnetic) and electrical leakage, electric shock or earth leakage (differential) protection. We also recommend installing an additional, single-pole, fuse-protected cut-off switch upstream, to provide additional protection by completely isolating the electric line with a contact gap of at least 3 mm when the fuses are removed.



OLIMPIA SPLENDID spa  
via Industriale 1/3  
25060 Cellatica (BS)  
[www.olimpiasplendid.it](http://www.olimpiasplendid.it)  
[info@olimpiasplendid.it](mailto:info@olimpiasplendid.it)

I dati tecnici e le caratteristiche estetiche dei prodotti possono subire cambiamenti. Olimpia Splendid si riserva di modificarli in ogni momento senza preavviso.